

Seite 10

▼ Edit Aktion Interaktiv

Define term(a)=2a+3
done
term(10) 23
Define term(x,y)=-7x+y
done
term(4,-5) -113

▼ Edit Aktion Interaktiv

2a+3 | a=10 23
-7x+3x*y-y^2 | x=4 and y=-5 -113

▼ Datei Edit Graph Aktion

	A	B	C
1	10	23	
2	5	13	
3	-4	-5	
4			
5			
6			
7			
8			
9			
10			
11			
12			
13			
14			
15			

=2·A1+3 ✓ X
B1 23

▼ Datei Edit Graph Aktion

	A	B	C
1	1	-0.5	
2	2	-1	
3	3	Unde ...	
4			
5			
6			

=1/(A1-3) ✓ X
 B1 Wert:
-0.5
 B1 Formel:
 $\frac{1}{A1-3}$
 B1 -0.5

Seite 11		<p> Edit Aktion Interaktiv $\text{expand}((x+2)(3-x))$ $-x^2+x+6$ </p> <p> Edit Aktion Interaktiv $\text{factor}(2b^2+4b)$ $2 \cdot b \cdot (b+2)$ </p> <p> Edit Aktion Interaktiv $\text{solve}(3x+5=-8x+13, x)$ $\left\{ x = \frac{8}{11} \right\}$ </p> <p> Edit Aktion Interaktiv $3x+5=-8x+13 \mid x=8/11$ $\frac{79}{11} = \frac{79}{11}$ </p> <p> Edit Aktion Interaktiv $\text{solve}(1/f=1/s+1/b, s)$ $\left\{ s = \frac{b \cdot f}{b-f} \right\}$ </p>
Seite 12		<p> Edit Zoom Analyse 53 129 -20 -5 Bog Real </p>

Fig. 4

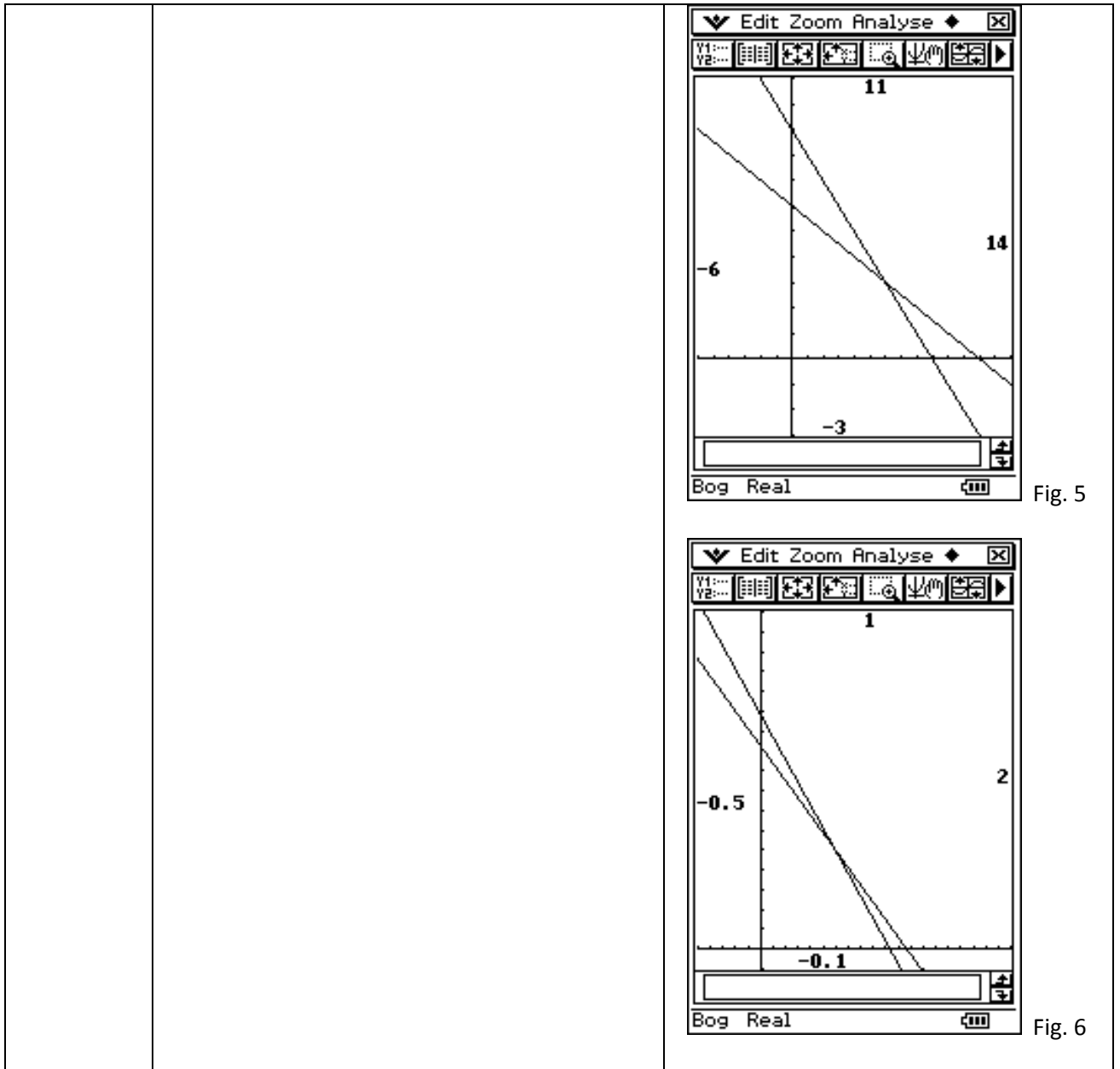
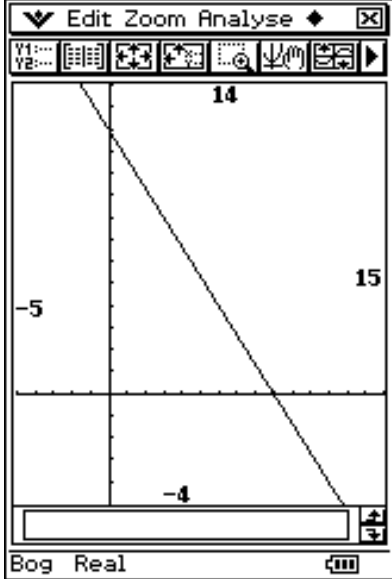
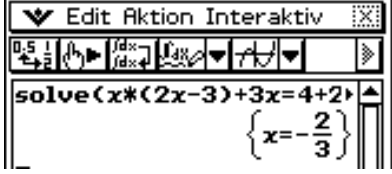
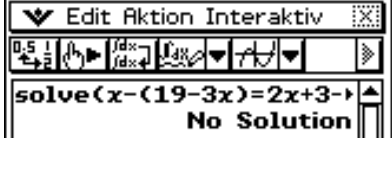

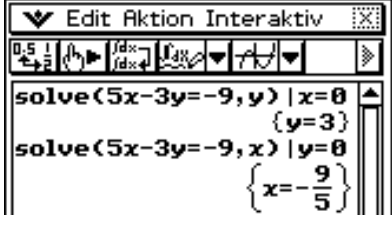
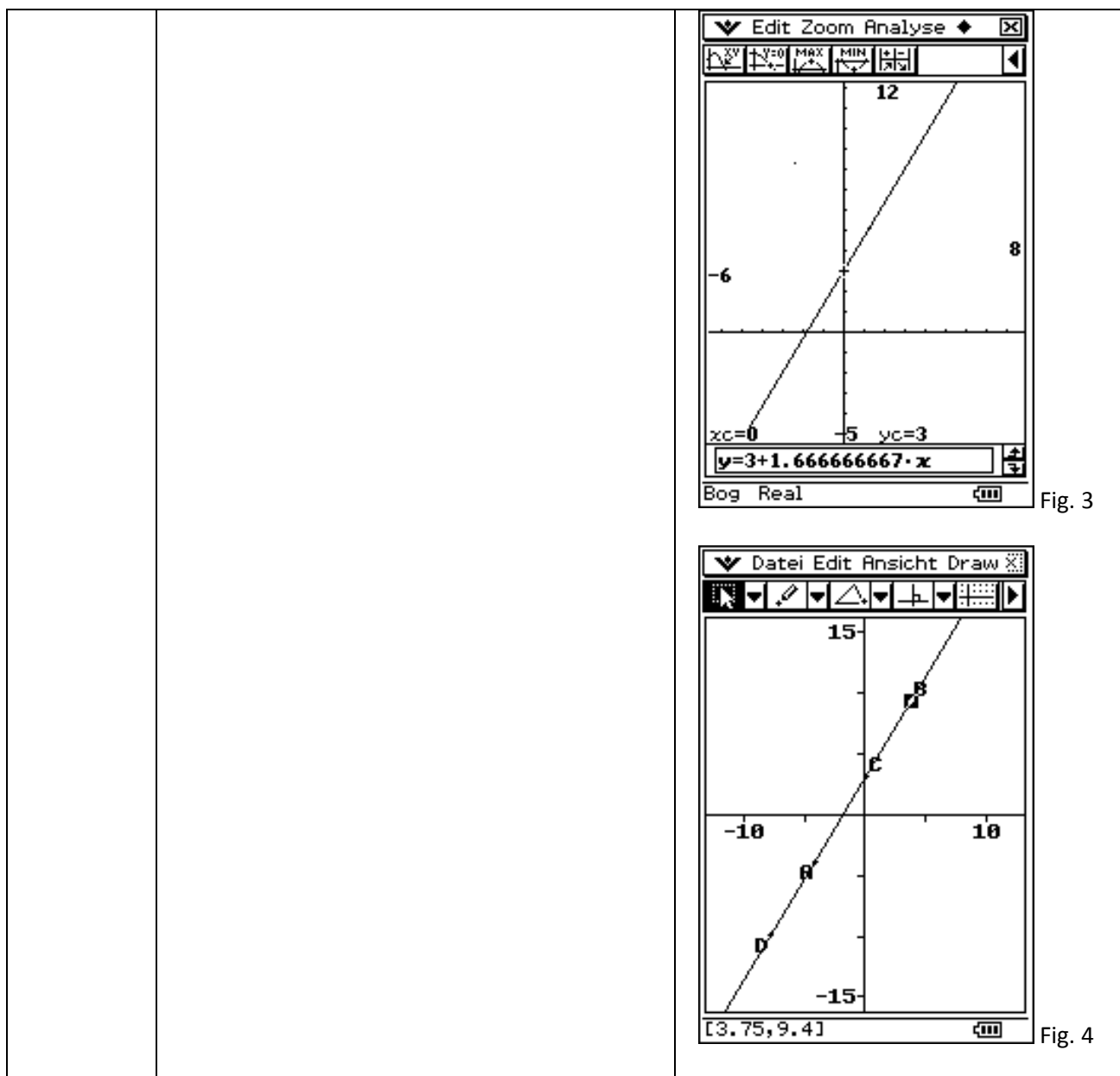
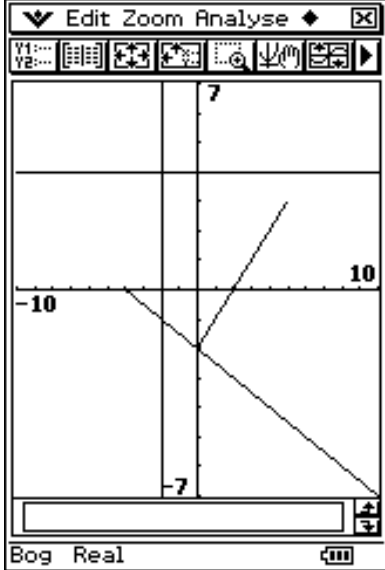
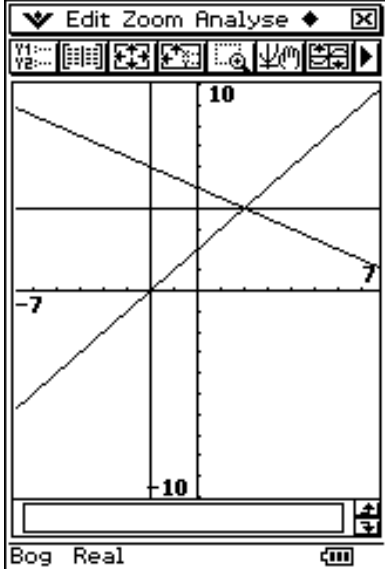
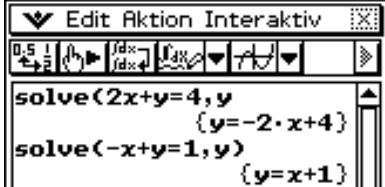

Fig. 5

Fig. 6

		 <p>Fig. 7</p>
<p>Seite 15 Beispiel 2</p>		 <p>Fig. 1</p>  <p>Fig. 2</p>  <p>Fig. 3</p>
<p>Seite 15 Beispiel 3</p>		 <p>Fig. 4</p>
<p>Seite 18 Beispiel</p>		 <p>Fig. 1</p>



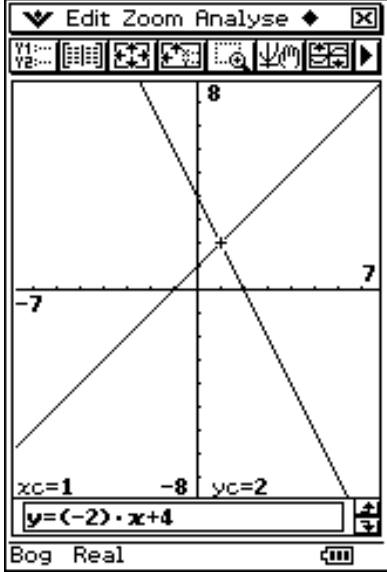
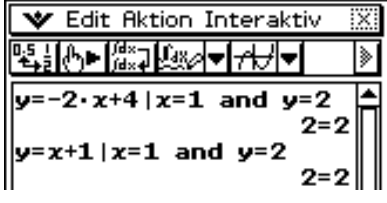
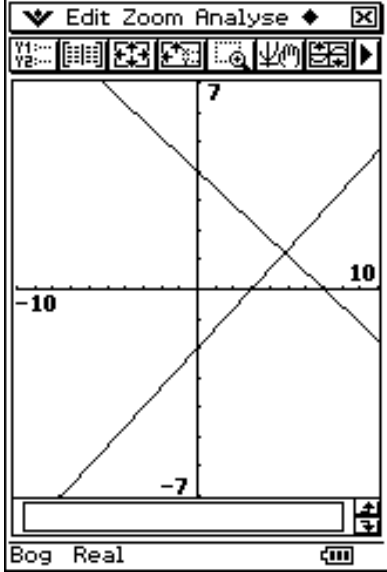

<p>Seite 19 Aufgabe 5</p>		 <p>Fig. 2</p>
<p>Seite 19 Aufgabe 10</p>		 <p>Fig. 4</p>
<p>Seite 20 Beispiel</p>		 <p>Fig. 2</p>

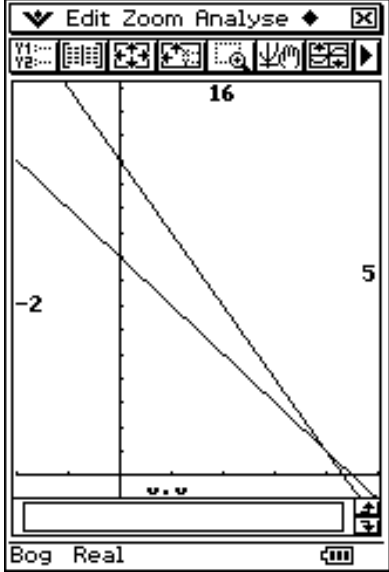
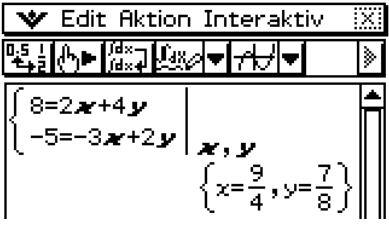
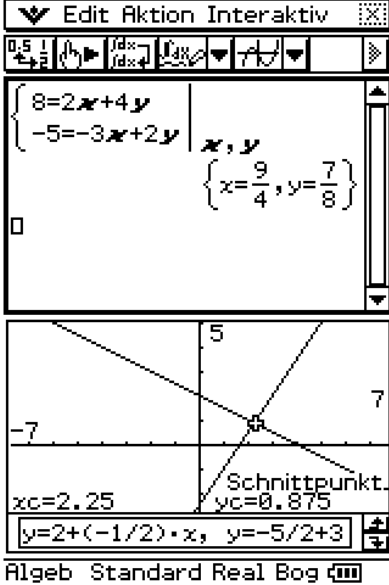
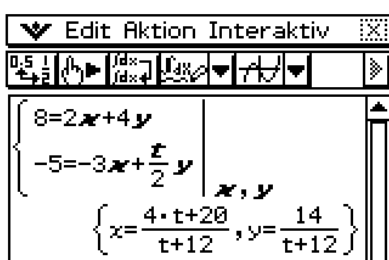
		 <p>Fig. 3</p>  <p>Fig. 4</p>
<p>Seite 21 Aufgabe 7</p>		 <p>Fig. 3</p>

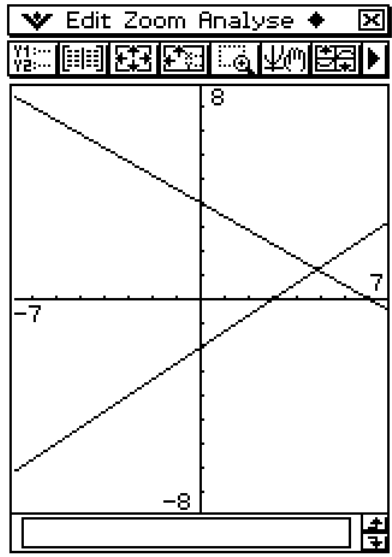
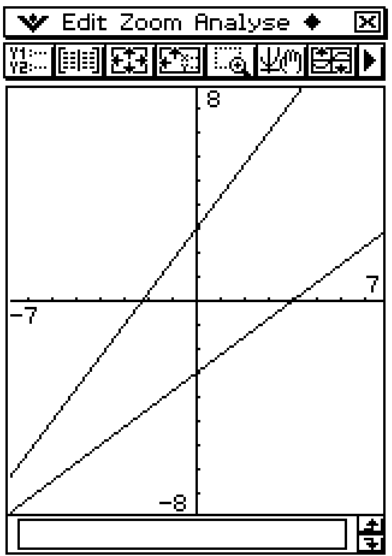
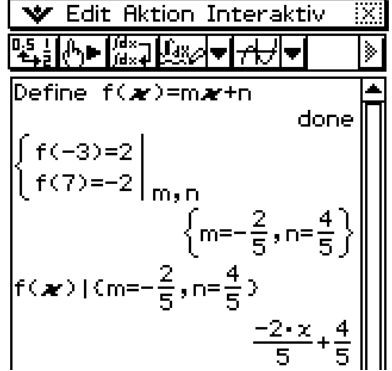
<p>Seite 28 Einführung</p>		
<p>Seite 28 Beispiel</p>		<div data-bbox="976 862 1366 1086">  <p>Fig. 1</p> </div> <div data-bbox="976 1097 1366 1680">  <p>Fig. 2/3</p> </div> <div data-bbox="976 1713 1366 1971">  <p>Fig. 4</p> </div>

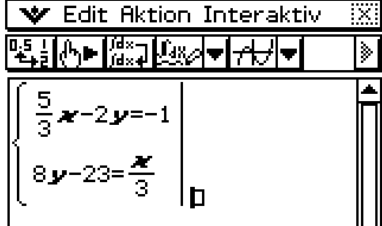
<p>Seite 29 Aufgabe 3</p>		 <p>Bog Real</p> <p>Fig. 1</p>  <p>Bog Real</p> <p>Fig. 2</p>
<p>Seite 29 Aufgabe 4</p>		 <p>Fig. 3</p>

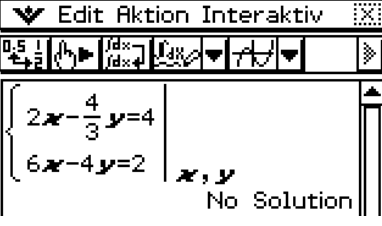
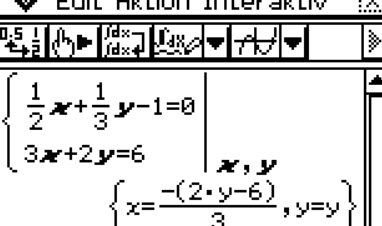
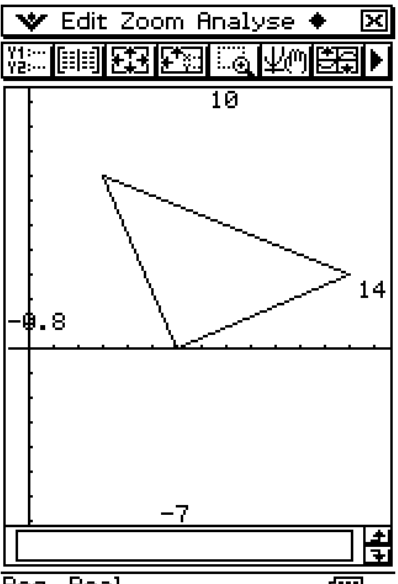
<p>Seite 29 Aufgabe 5</p>		 <p>Fig. 4</p>  <p>Fig. 5</p>
<p>Seite 30 Aufgabe 7</p>		 <p>Fig. 1</p>  <p>Fig. 2</p>
<p>Seite 30 Aufgabe 10</p>	<p>Im Grafik- und Tabellenmodus von CASIO sind keine Gitterpunkte und Eckpunktbezeichnungen sichtbar zu machen.</p>	 <p>Fig. 3</p>

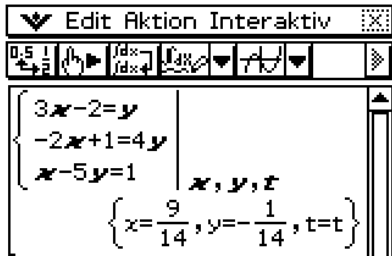
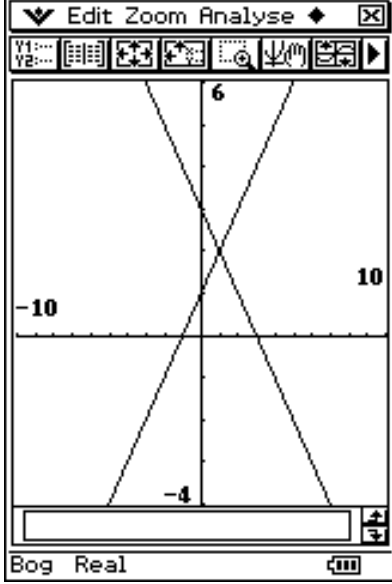
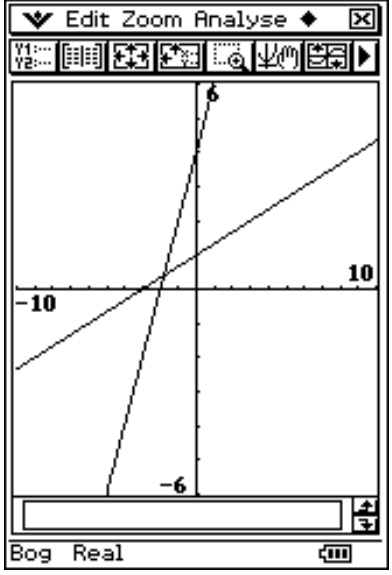
<p>Seite 34 Aufgabe 8</p>		 <p> $\begin{cases} 3x-2=y \\ -2x+1=4y \\ x-5y=1 \end{cases} \quad x, y, z$ $\left\{ x = \frac{9}{14}, y = -\frac{1}{14}, z = t \right\}$ </p> <p>Fig. 2</p>
<p>Seite 41 Training Aufgabe 3</p>		 <p>Fig. 1</p>  <p>Fig. 2</p>

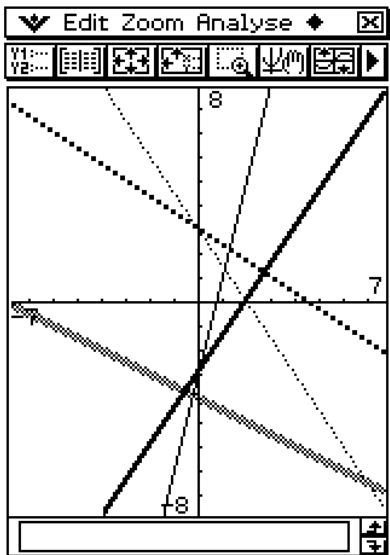
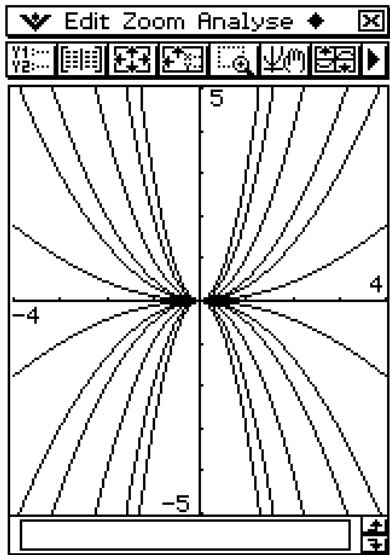
<p>Seite 45 Forschungs- auftrag 1</p>		 <p>Fig. 1</p>
<p>Seite 45 Forschungs- auftrag 2</p>		 <p>Fig. 2</p>

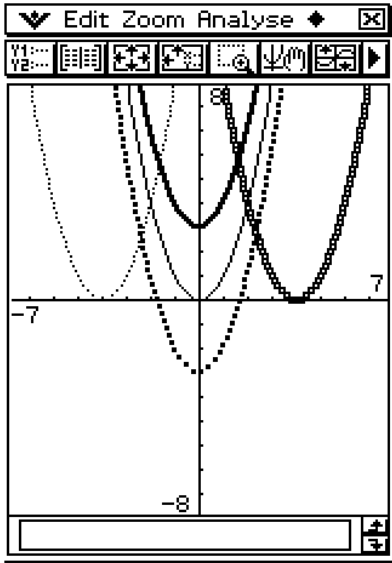
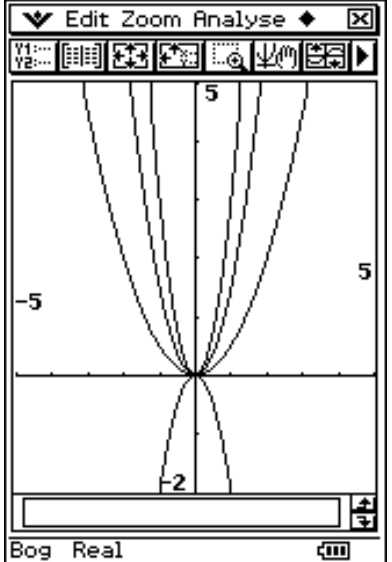
<p>Seite 45 Forschungs- auftrag 3</p>		 <p>Bog Real</p>	<p>Fig. 3</p>
<p>Seite 47 Beispiel 2</p>		 <p>Bog Real</p>	

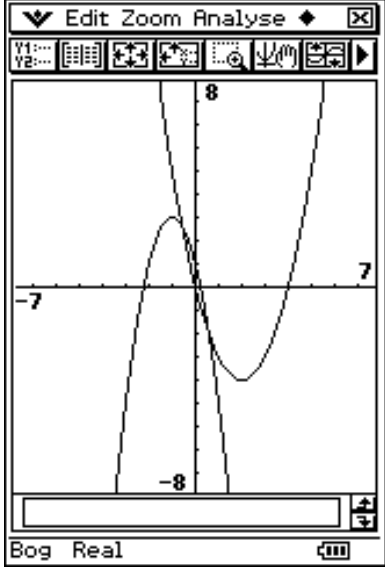
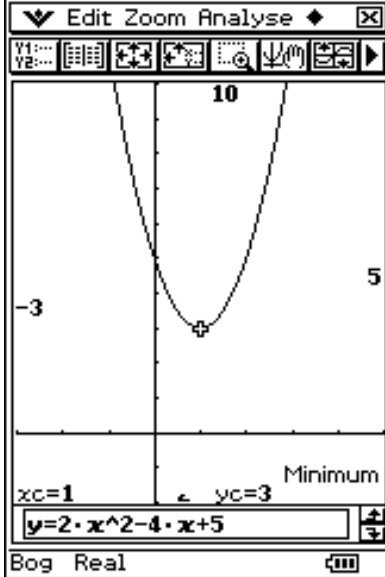
<p>Seite 51 Beispiel</p>		 <p>Fig. 1</p>
<p>Seite 54</p>		

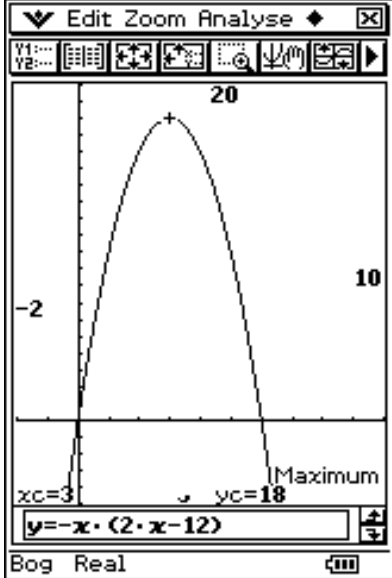
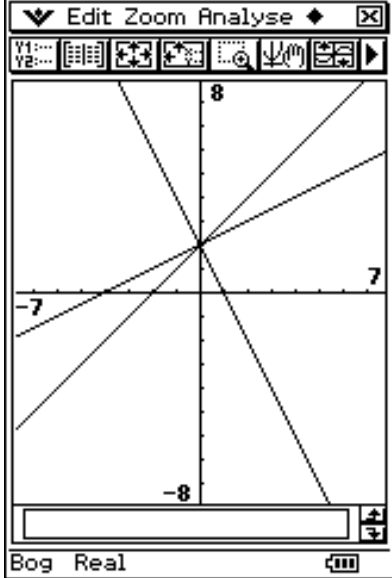
<p>Seite 57</p>		 <p>Fig. 2</p>
<p>Seite 59 Einführung</p>		



		
<p>Seite 60 Beispiel 2</p>		
<p>Seite 61 Aufgabe 7</p>		

Fig. 4

<p>Seite 62 Aufgabe 10</p>		
<p>Seite 69 Beispiel</p>		<div style="display: flex; flex-direction: column; align-items: flex-end;"> <div style="margin-bottom: 20px;">  <p>Fig. 1</p> </div> <div>  <p>Fig. 2</p> </div> </div>

	<p>Zunächst wird nur der Schnittpunkt mit dem kleinsten x-Wert angezeigt.</p> <p>Nach dem Drücken von [▶] der Cursor-Wippe wird der zweite Schnittpunkt angezeigt (Fig. 4_2).</p>	 <p>Fig. 3</p>  <p>Fig. 4_1</p>
--	---	--

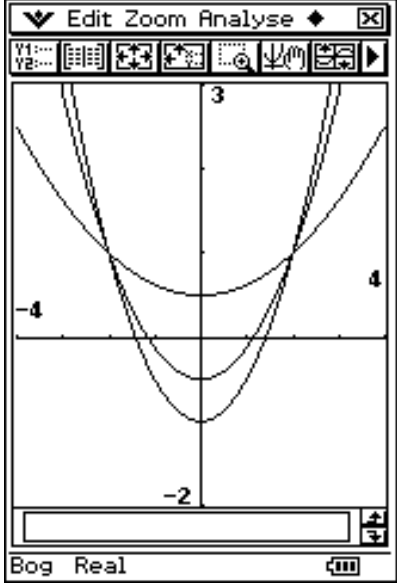
		 <p style="text-align: right;">Fig. 4_2</p>
Seite 70 Aufgabe 5		 <p style="text-align: right;">Fig. 1</p>
Seite 70 Aufgabe 6		 <p style="text-align: right;">Fig. 2</p>

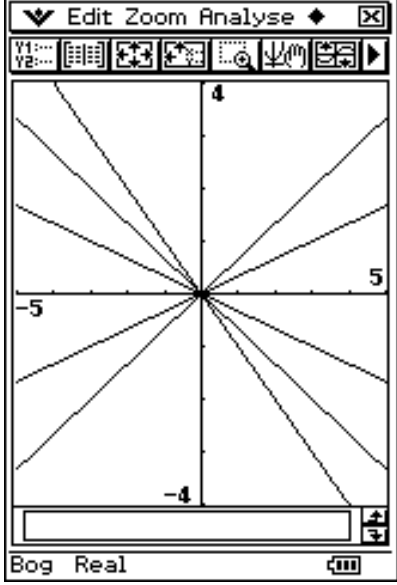
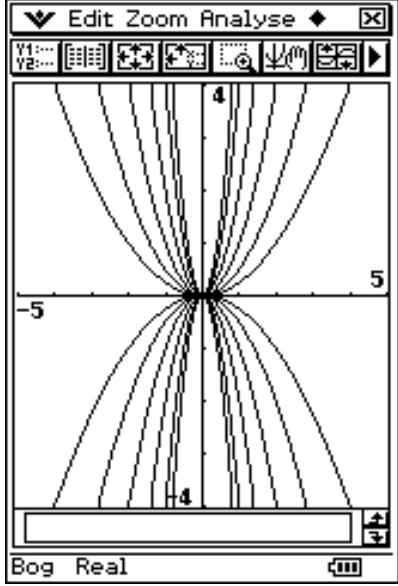
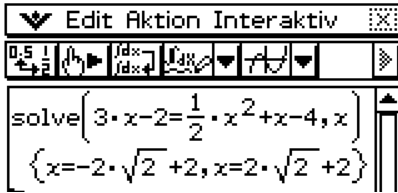
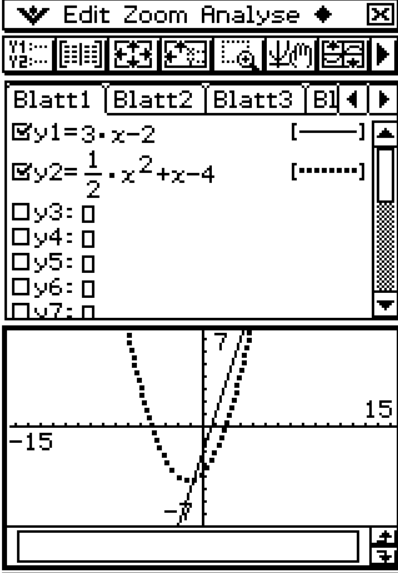
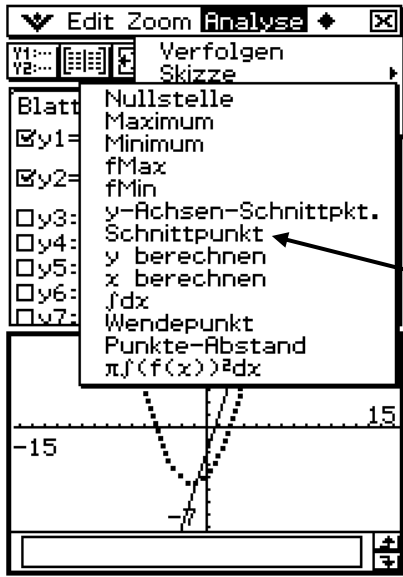
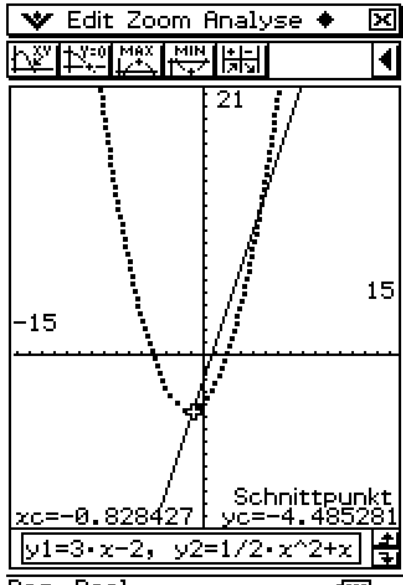
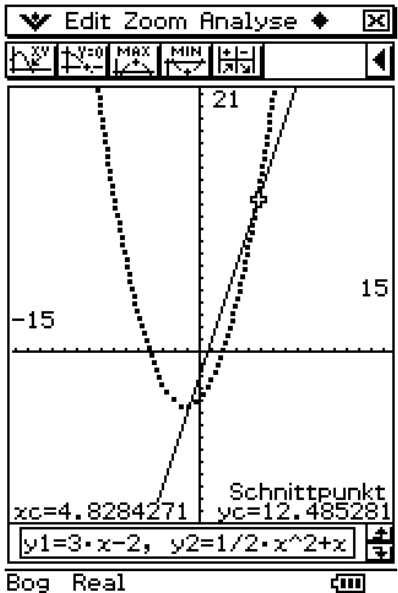
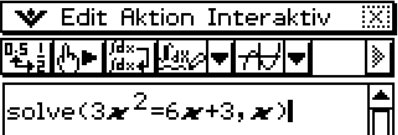
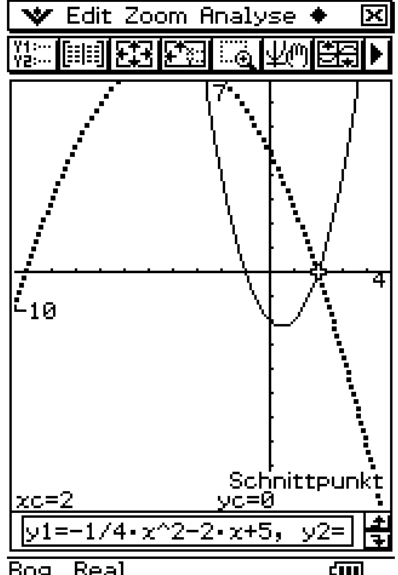
Seite 74
Beispiel

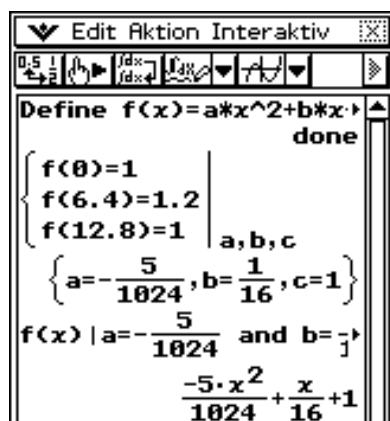
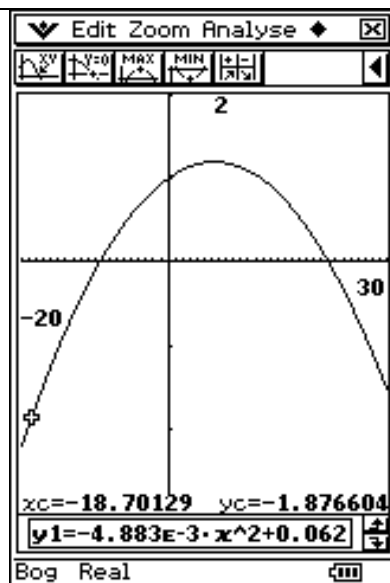

Fig. 1

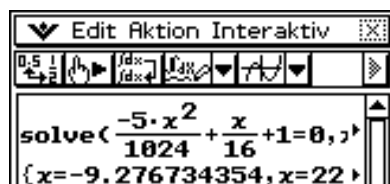
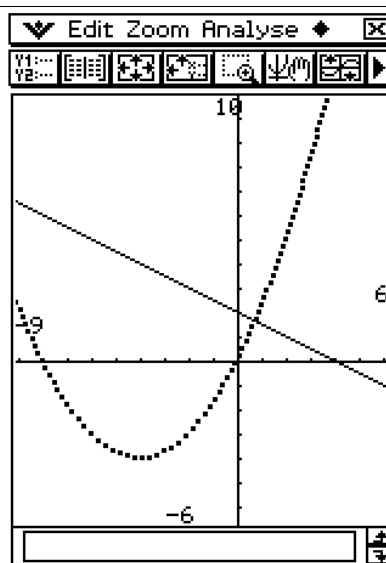

Fig. 2_1

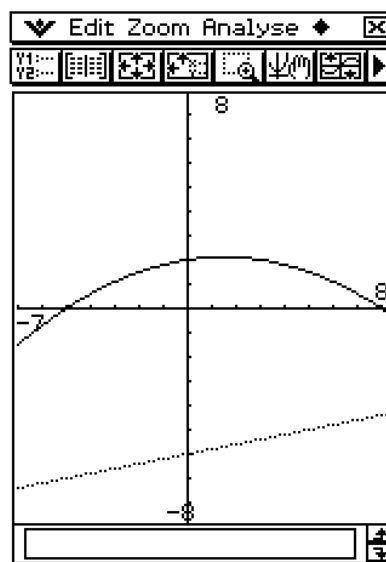

Fig. 2_2

Seite 76
Aufgabe 5



Bog Real Fig. 1



Bog Real Fig. 2

Seite 79
Aufgabe 5

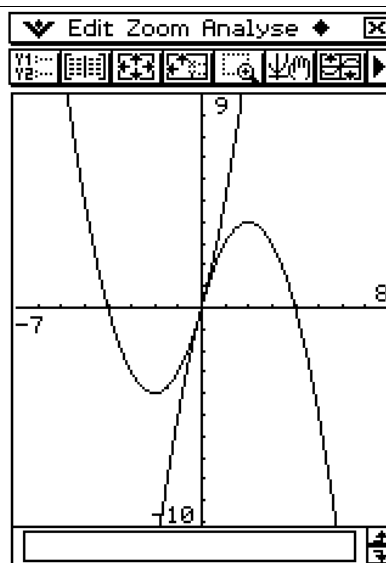

Bog Real Fig. 1

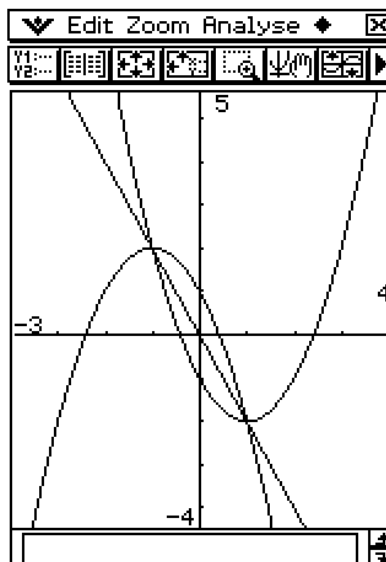

Bog Real Fig. 2

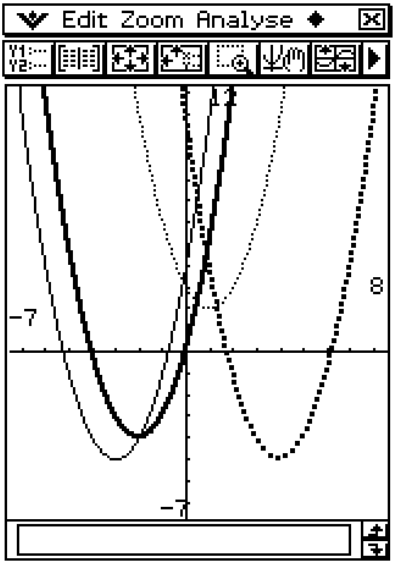
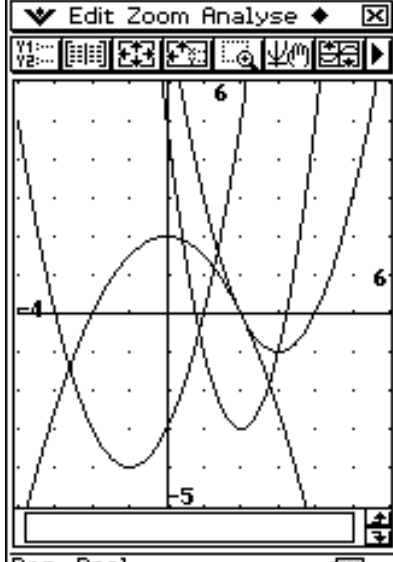
<p>Seite 79 Aufgabe 6</p>		 <p>Fig. 3</p>
<p>Seite 83 Training Aufgabe 3</p>		 <p>Fig. 1</p>

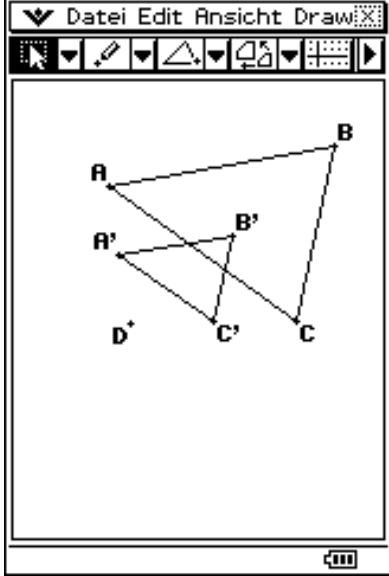
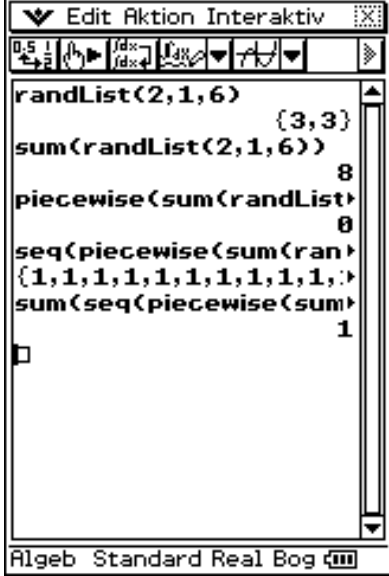
<p>Seite 119 Exkursion</p>		 <p>The calculator screen displays a geometric diagram with points labeled A, B, A', B', C, C', and D'. The diagram shows a large triangle with vertices A and B, and a smaller triangle with vertices A' and B'. Points C, C', and D' are also shown, forming a complex geometric figure. The calculator interface includes a menu bar with 'Datei Edit Ansicht Draw' and various drawing tools.</p> <p style="text-align: right;">Fig. 1</p>
<p>Seite 137</p>	<p>Für diese Berechnung ist auf eine aktuelle Version des Betriebssystems zu achten.</p>	 <p>The calculator screen shows a sequence of commands and their results in a list format:</p> <pre> randList(2,1,6) {3,3} sum(randList(2,1,6)) 8 piecewise(sum(randList)) 0 seq(piecewise(sum(ran)), (1,1,1,1,1,1,1,1,1,1)) sum(seq(piecewise(sum))) 1 </pre> <p>The calculator interface includes a menu bar with 'Edit Aktion Interaktiv' and various function keys. The status bar at the bottom reads 'Algeb Standard Real Bog'.</p> <p style="text-align: right;">Fig. 1</p>

Seite 141
Exkursion

	list1	list2	list3
1	172		
2	171		
3	155		
4	163		
5	160		
6	168		
7	152		
8	152		
9	152		
10	152		
11	153		
12	154		
13	154		
14	156		
15	157		
16	157		

Calc

[16] = 157

Bog Auto Standard

Fig. 1

	list1	list2	list3
1	152		
2	152		
3	152		
4	152		
5	153		
6	154		
7	154		
8	155		
9	156		
10	157		
11	157		
12	159		
13	160		
14	160		
15	163		
16	167		

Calc

[16] = 167

Bog Auto Standard

Fig. 2

min(list1)	
max(list1)	152
median(list1)	172
mean(list1)	157
	159.6198476

Fig. 3

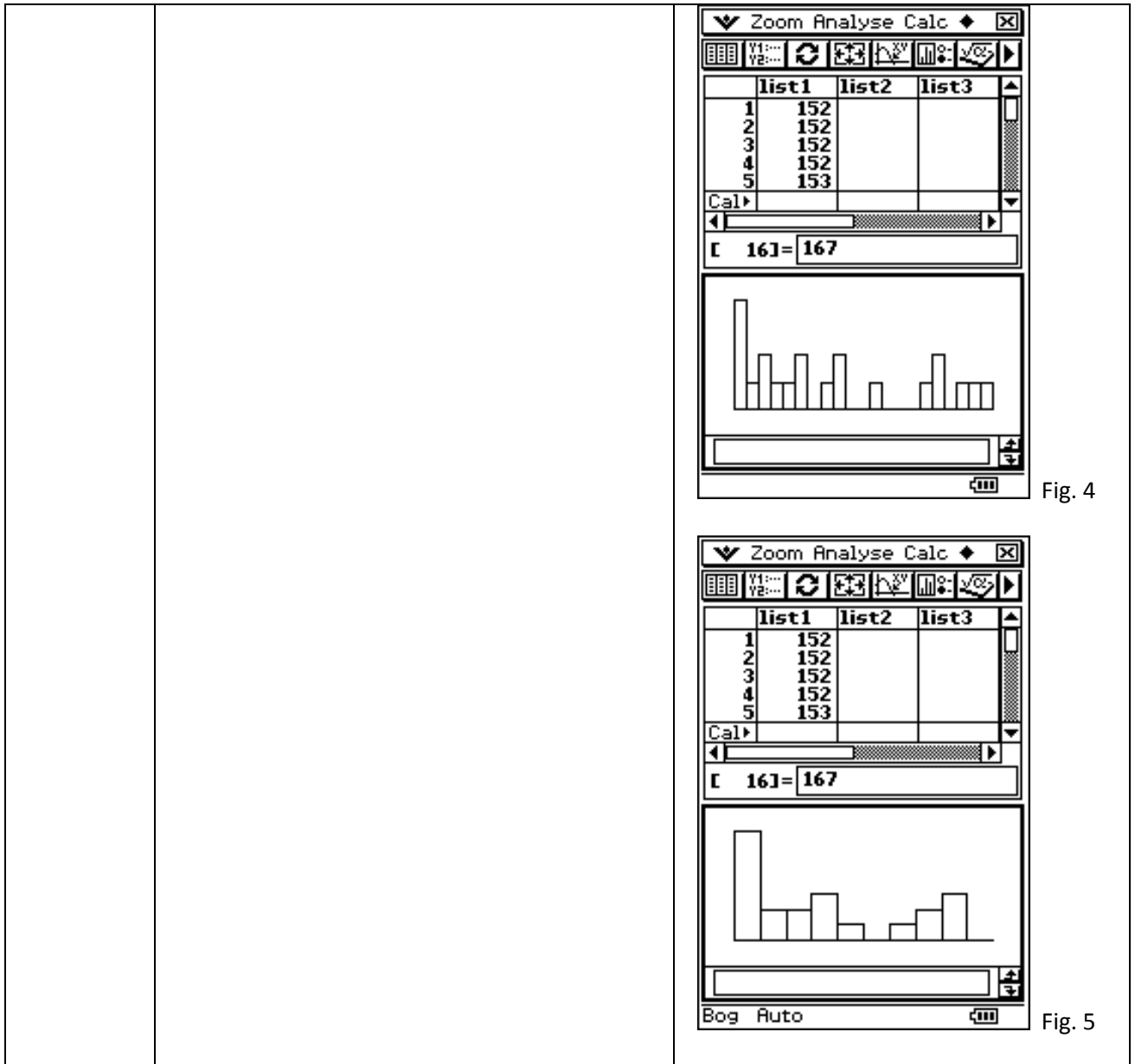

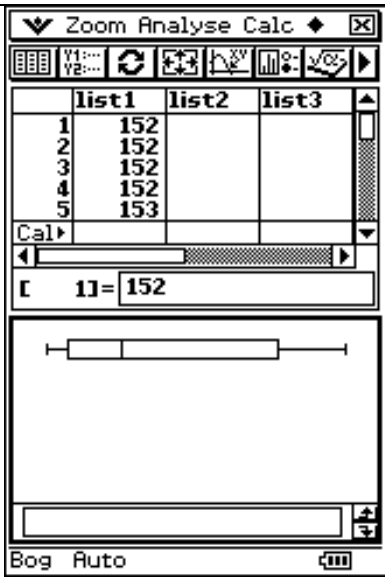
Seite 142 Exkursion	Die Feinheiten wie mit dem TI lassen sich nicht anzeigen.	 <p>Zoom Analyse Calc</p> <table border="1"><thead><tr><th></th><th>list1</th><th>list2</th><th>list3</th></tr></thead><tbody><tr><td>1</td><td>152</td><td></td><td></td></tr><tr><td>2</td><td>152</td><td></td><td></td></tr><tr><td>3</td><td>152</td><td></td><td></td></tr><tr><td>4</td><td>152</td><td></td><td></td></tr><tr><td>5</td><td>153</td><td></td><td></td></tr></tbody></table> <p>Calc</p> <p>11= 152</p> <p>Bog Auto</p>		list1	list2	list3	1	152			2	152			3	152			4	152			5	153		
	list1	list2	list3																							
1	152																									
2	152																									
3	152																									
4	152																									
5	153																									

Fig. 1 -3